

AQUA4D[®]

H-A PRO 200-300-400



User Manual

v2.1

TABLE OF CONTENT

Safety instructions	3
Introduction	4
Package contents	4
Installation	5
Control Unit Operation	12
Settings	14
Troubleshooting	15
Contact	16





SAFETY INSTRUCTIONS

Only qualified personnel are authorized to perform the installation, commissioning, configuration and maintenance of AQUA4D® systems. He or she must have received the operator's authorization to carry out the specific operations. The electrical connections for the electronic control boxes (Command), as well as the installation of the Treatment Units (TU), may only be established by specialized staff.

These staff must have read this operating manual and must comply with the instructions therein. Before commissioning the system, check once again that all the connections have been correctly established and that the electric cables and pipe fittings are not damaged.

Do not operate damaged machines and ensure that you protect them from being started up accidentally. Mark these machines as defective. Any repairs that are not set out in this manual may only be carried out by an authorized after-sales service. The AQUA4D® system was built and inspected in accordance with our quality requirements and left our facility in perfect technical condition, in compliance with applicable European technical and safety directives and standards.

As the installer and/or user, you are responsible for complying with the safety instructions set out in the installation instructions in this manual and the local standards and directives. You will sometimes see the system written as "PRO" all in capital or like a regular word, "Pro" it all depends on the flexible mood of the Marketing dept.

If your AQUA4D® system has to be repaired, please clean it before returning it to the after-sales service and use the original packaging.

INTRODUCTION

The AQUA4D team is very glad that you choose to put your trust in our product and acquire a PRO system for your exploitation. The PRO series have been designed specifically to be equipped on **high water flow** networks.



We ran tests in the US, Brazil, Spain and of course Switzerland, where our company is located. Various terrains and experiences taught us to face the many challenges of modern irrigation.

This document will help you install and start using your AQUA4D PRO system, but please feel free to call your AQUA4D contact or distributor if you need any help, we will be glad to help you get started and improving the way you can irrigate with AQUA4D.

PACKAGE CONTENTS

- 1x H-A PRO
- 2x Alignment compensator
- 1x Set of nuts and bolts
- 1x Air valve, 2"
- 1x Grounding rod and cable
- 1x Documentation leaflet

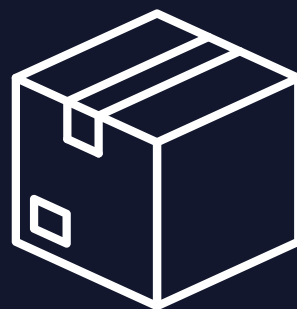

INSTALLATION

This document will cover all the points to setup your new AQUA4D PRO system for optimal operation. Please read the entire document before you start working on the system itself.

Safety instructions and required equipment

The empty structure, not connected to the water network, weighs around 200 kg. At least 2 people are recommended to install it, using suitable lifting equipment such as a hoist or crane. To secure the flanges, the following tools or equivalent are required :

- Torque wrench equipped with a 30mm socket
- 30mm wrench
- Level
- Philips 2 screwdriver (PH2)
- Adjustable wrench

For optimum operation and stability, the system should be installed on a concrete slab with at least 80 cm of free space around it to allow comfortable installation and access for maintenance. The feet of the structure can be adjusted if necessary. Use your level to check that the system is straight. The system is rated for a maximum pressure of 10 bars (145 psi), Do not exceed this limitation.

Mechanical specifications



H-A Pro 100 to
400

Systèmes prêt à
l'emploi pour la
micro-irrigation
(grand débit)

You can consult the mechanical specifications for your product on the corresponding technical data sheets, available on our website.

<https://docs.aqua4d.com/products>

General diagram

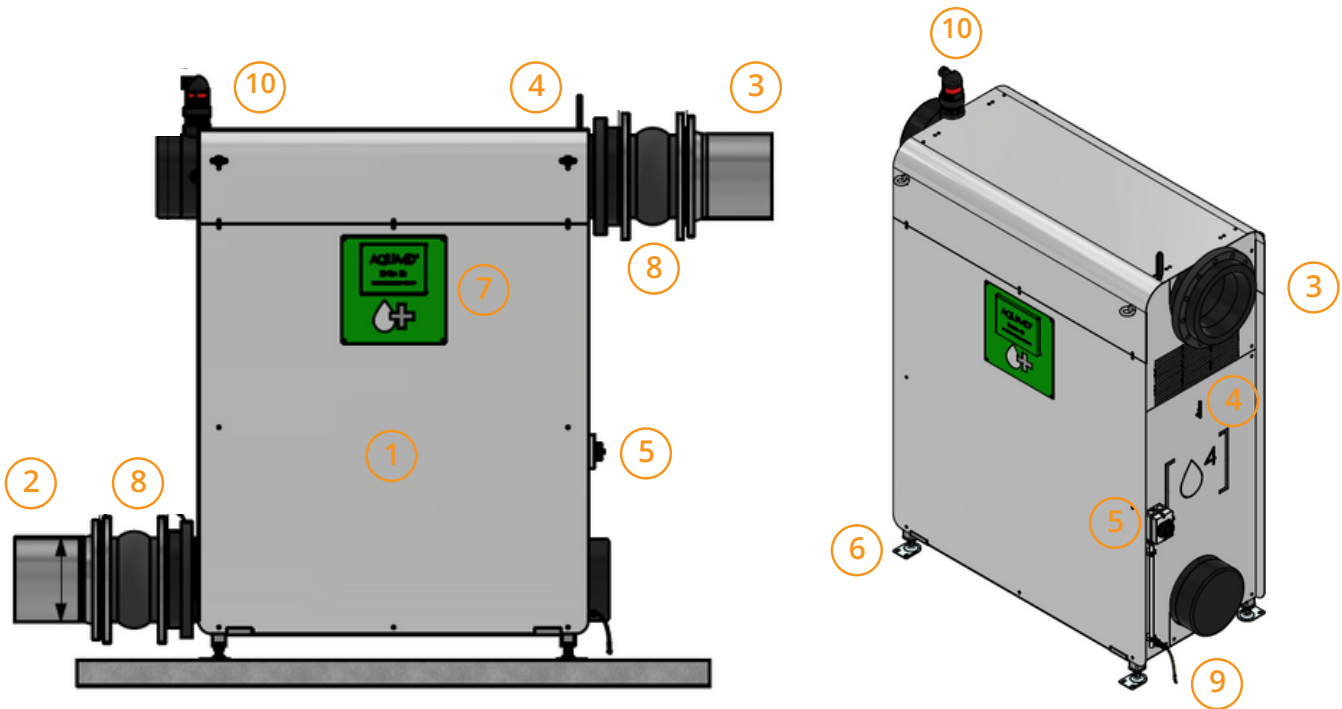

1. Main Structure
2. Water inlet flange
3. Water outlet flange
4. Communication and GPS antennas
5. Power Box

6. Adjustable foot
7. Control Unit
8. Alignment compensators
9. Grounding cable => to ground rod
10. Air Valve, 2"

Connecting the water input and output

The flanges on the water input and output are of DN type, the size depends on the system you acquired. You will need equivalent flanges on the connecting pipes from your water network. If your network is of a different size, adaptors are available. Please contact your local supplier or the AQUA4D support if you need more directions on this matter. Both input and output will use the same mounting method to the existing water network.

Connect the input/output with its counterpart and ensure a good sealing between the pipes. Use the provided nuts and bolts, 8 of each per side, do not tighten them at first, just place them all around the flange. Then start to tighten the bolts progressively until you achieve **60 Nm** with your torque wrench.

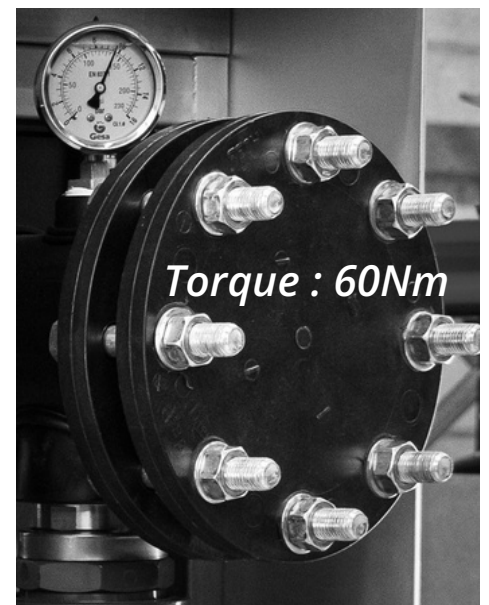

Connecting the antenna

The PRO system requires two antennas, one for the GPS (localization) and the other for the LTE-M (data). One is already mounted and ready to go, the other one is located either on the side of the system or in the accessories box, if applicable.

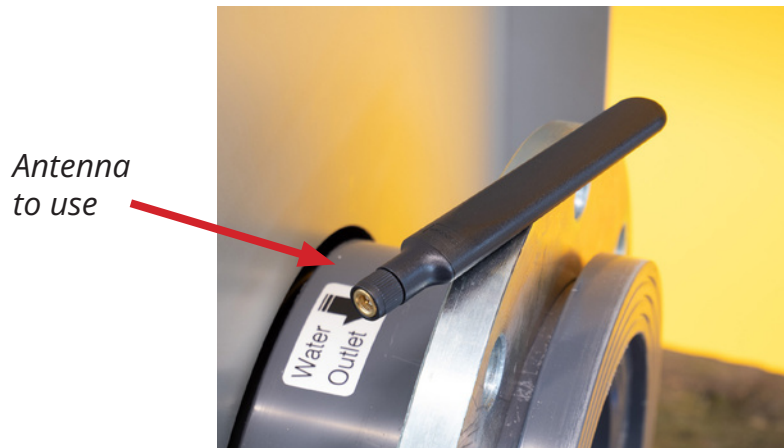

Detach the antenna and screw it on the top connector, above the hole drilled in the top cover panel.



The antenna is now connected to the control unit and will be able to communicate if an LTE-M network is available in the area.

Mounting the air valve

The AQUA4D H-A Pro must be fitted with the supplied air valve, to evacuate air when filling the system with water.



Mounting video



- Scan the QR Code or click on [this link](#) to access the video on YouTube -

On the top of the H-A Pro, there is a 2" thread for attaching the valve. Use a suitable spanner to fit the valve. The valve is already prepared with Teflon tape to ensure it is watertight.

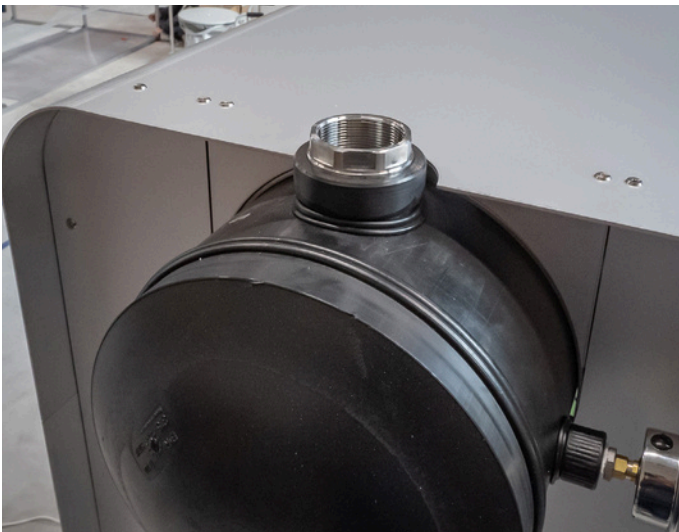

Connecting the power supply

The system needs to be connected to the power network. 3 wires need to be connected to the power box, Phase Line (L), Neutral (N) and Ground (PE) • First of all, make sure that the **power is shut down** in your main breaker box to avoid any electrical injury.

Open the power box on the side of the AQUA4D PRO, by removing the two screws on the top and bottom.



There is a dedicated cable gland for your power cable. Pass the cable through it with a sufficient length to be able to work comfortably. Then strip the cable of 5cm of insulation (total) and the copper wires of 1 cm.

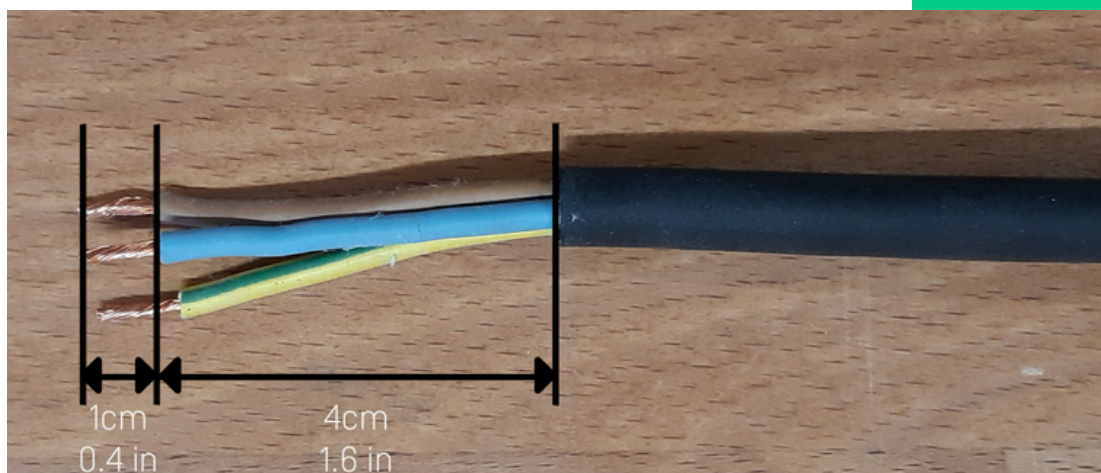

Below, you can see on the picture on the left the initial state of the box when you open it. The cable in the right cable gland is the one you need to equip, like on the picture on the right side. Insert the wires in their corresponding port according to the markings of the connecting block.

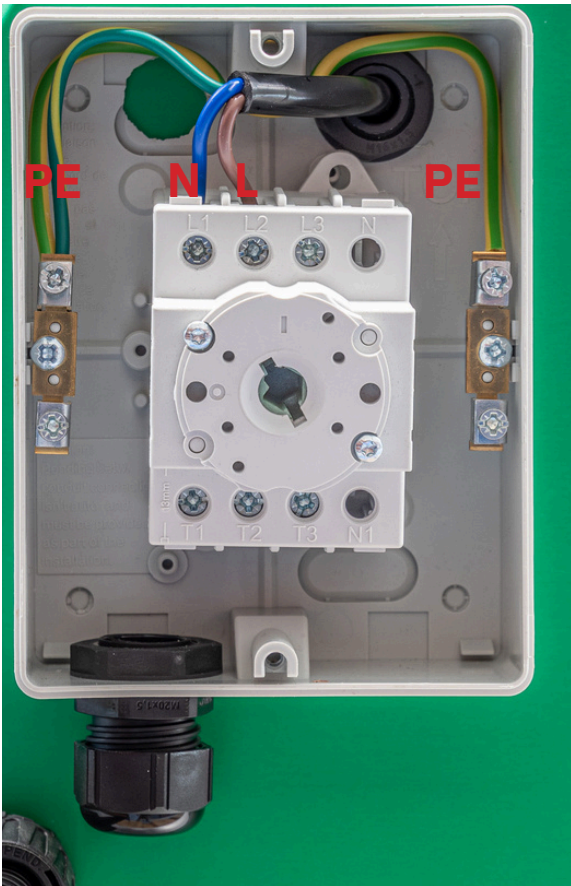

Before inserting the power cable

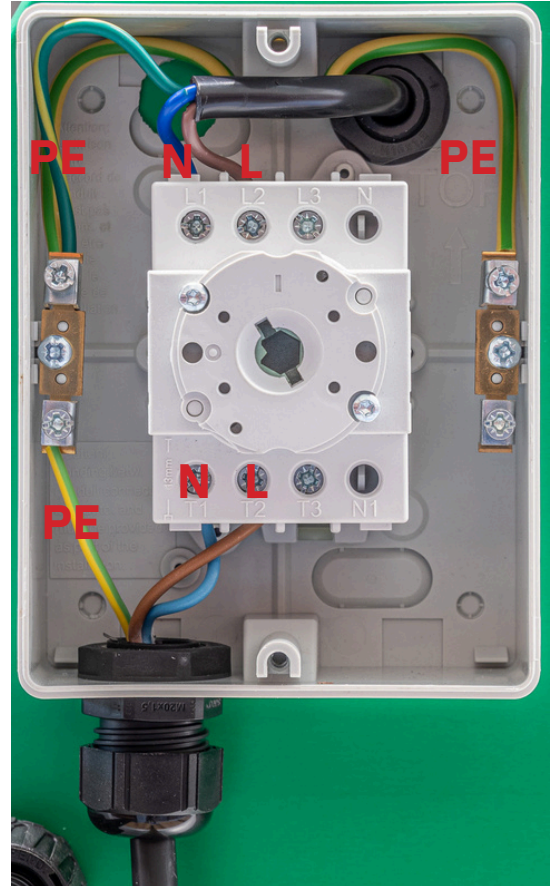
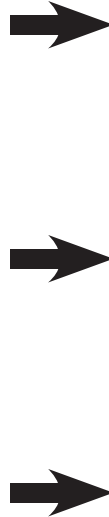

After the power cable connexion has been completed

T1 = L1 = **L wire** T2 = L2 = **N wire** **PE** on the side terminals

Put back the lid of the power box with the two screws and tighten them with your screwdriver.

Put the power back on (circuit breaker) and turn the rotary switch of the power box in the ON position.

The Control Unit will initialize and after a few seconds the system will start automatically.

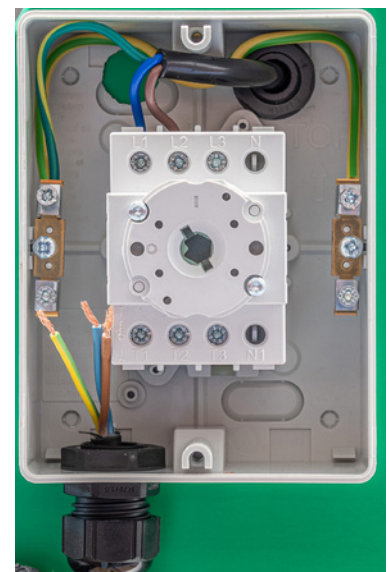

Inserted power cable, before connexion

Opening the water flow

The system is now ready to treat the water. To ensure a smooth start, **increase the water flow gradually** to avoid damage to the piping network.

During this process, if you notice any leak on the flanges, stop the water flow and tighten the bolts a bit more. Then start again and see if the leak is gone.

If you are unable to achieve a watertight system, please contact a specialist of the AQUA4D support.

Once you have reached the optimal water flow and pressure for your network, the installation of your AQUA4D PRO system is done.

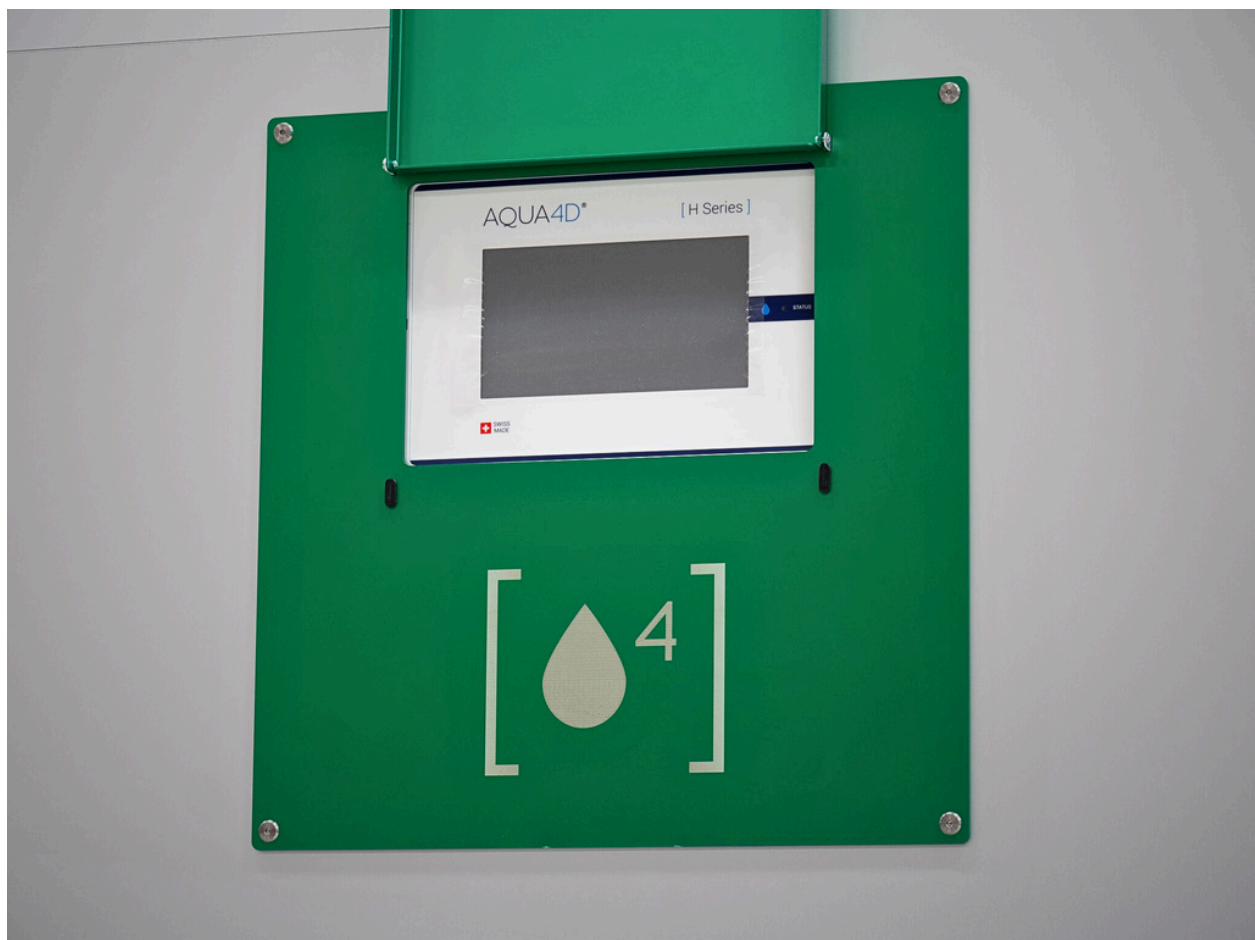

CONTROL UNIT OPERATION

The Control Unit is preconfigured in our factory and is ready to go as soon as it is powered.

Here's a list of the settings that can be changed or updated if the need arises.

- *Language*
- *Time*
- *Date*
- *Number of Treatment Units connected*

To access these settings, restart the CU either by using the “power”  icon on the screen or by turning it off and on again with the main electrical switch

The system will reboot and you will see a “**START**” button below the AQUA4D logo, press that button to enter the initialisation menu.

(Be mindful that if you don't press that button, the Control Unit will start itself using the last known configuration.)



You will then be guided through the different settings and when you're done the Control Unit will go to its normal operation mode.

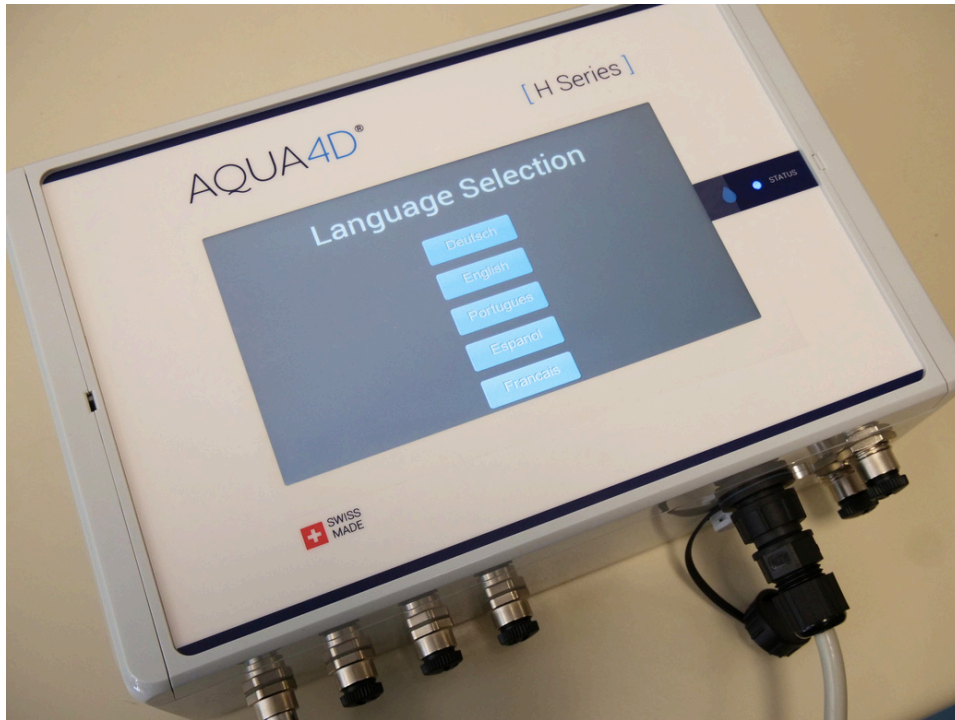

Language selection

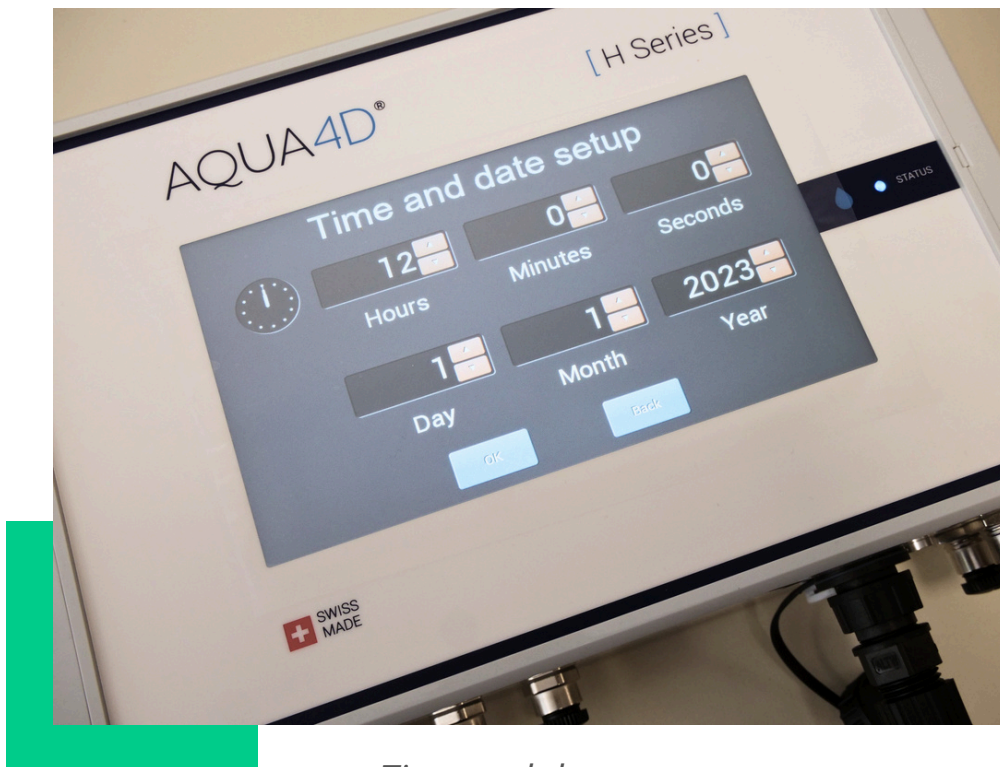

Time and date setup

SETTINGS

To access the settings menu, press the "settings" icon  and enter code **111**.

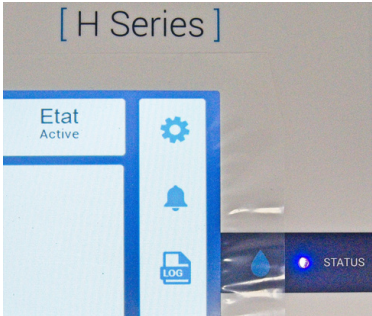

The following options can then be modified:

- Time
- Date
- Language
- Factory reset

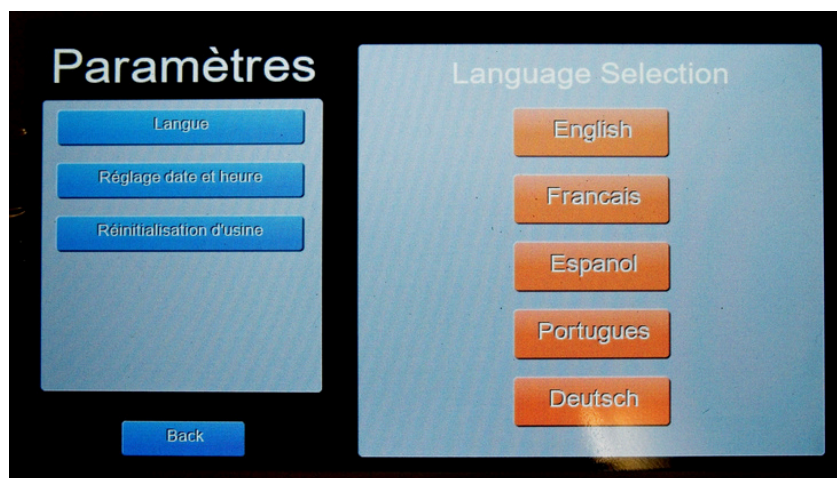

TROUBLESHOOTING

The Control Unit screen stays dark and the “status” light is off

Verify that the power supply is turned ON and the power cable correctly connected to the power box

There is water coming from inside the AQUA4D H PRO system

Stop the water flow and contact your distributor or the AQUA4D support.

Unable to connect the flanges

Make sure that your flanges are compatible with the correct DN diameter, we can also provide adapters if needed.

Water is leaking from one of the flange

Use your torque wrench to verify that the correct force is being applied to all the bolts around the flanges.

My problem is not listed here

Please contact your supplier or the AQUA4D support and describe your problem.



AQUA4D

- by Planet Horizons Technologies SA -



Planet Horizons Technologies SA - AQUA4D

*Ecoparc de Daval A9
3960 Sierre
Switzerland
+41 27 480 3035
info@aqua4d.com*

Copyright © 2024 AQUA4D® All Rights Reserved

www.aqua4d.com